

Micro Fiber Screen Cleaner

Artwork Template

Marketing Card Template - 2" x 3.5", 4 color process, Horizontal or Vertical

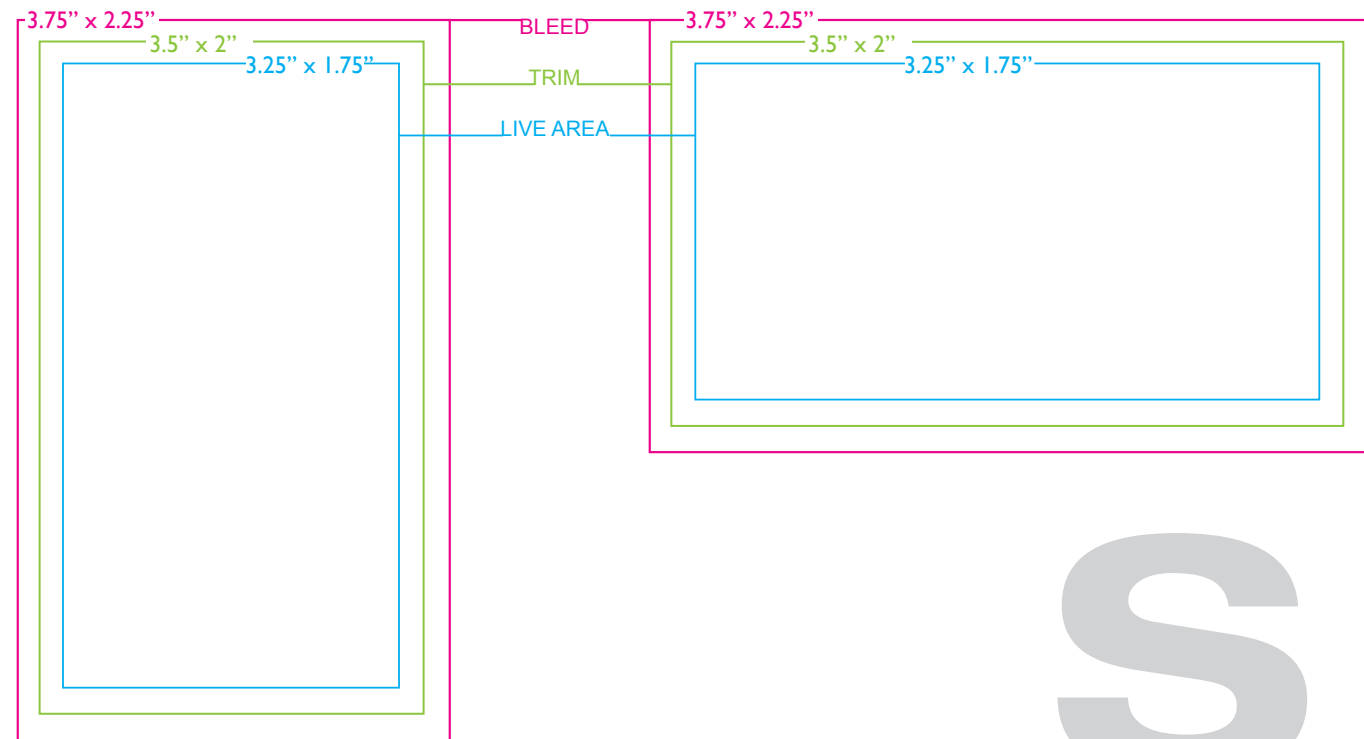

- Open & Edit this PDF in Adobe Illustrator to create your vector artwork.
- All artwork must go out to the **bleed** line, unless the background is white.
- Text and Logos must be off of the **trim** line and within the **live area**.
- Background images may bleed off the edge of the grip and card (full bleed).

File Requirements:

- We LOVE Vector Artwork that is 300 + DPI & 800 DPI for the GRIP looks Amazing.
- We print CMYK. If using Spot/PMS colors, please supply Best Match CMYK Values.
- We use the PC version of Adobe CS4 and CANNOT use MAC fonts.
- MAC users must provide PC Fonts or Outline your MAC fonts.
- We need CS4 compatible .EPS, .AI or .PDF files in CMYK format ... Min 300 DPI.
- We can accept Hi-Res TIF, PSD, Photoshop EPS, and PostScript files from CS4.
- Supply Linked Files, OR Save with option "Include all Linked Files".
- Scanned Images & Photographs should be 300+ DPI and at 100% size.
- Line Art Scans should be 800 - 1200 DPI at 100% Size.
- Quark / Corel Draw: Only PDFs from these programs are usable.

DIGI CLEAN:

- Digi Clean can be placed anywhere and in any direction on the card.
- Digi Clean is printed digitally, 4 color process (CMYK), full bleed.
- Digi Clean Type Size cannot be smaller than 6 pt.
- Digi Clean looks best with Vector artwork.

CARD:

- Card is printed offset, 4 color process both sides (CMYK), full bleed.
- Card can be designed vertical or horizontal.
- Back has Digi Clean® instructions.
- Card Type Size cannot be smaller than 6 pt ... 4 pt font for legal.

FONTS:

- Type I PostScript fonts ONLY ... NO TrueType fonts.
- Include Screen Font (font suitcase / bitmap font) and all PostScript printer fonts.
- Make sure to include fonts that are embedded in imported graphics.
- If Type I fonts are not available, convert to curves to preserve file appearance.

Send artwork to art@egrips.com , up to 20 MB. Files larger than 20 MB should be sent via YouSendIt, or uploaded to our FTP site ... email for FTP login info.

Send artwork questions to graphics@egrips.com

S

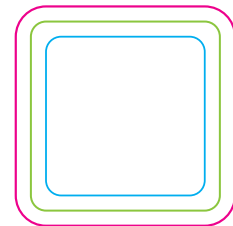

1" DSQ

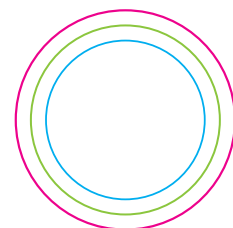

1" DSC

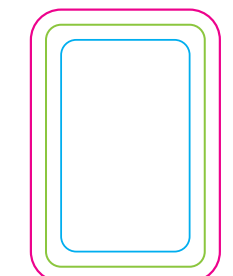

.8" x 1.3" DSR

A

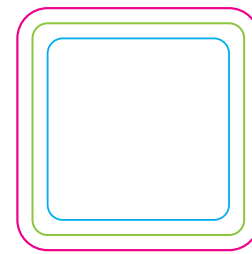

1.1" DAQ

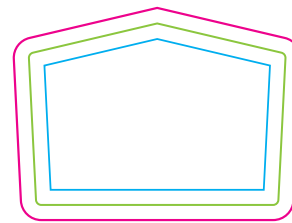

.9" x 1.3" DAG

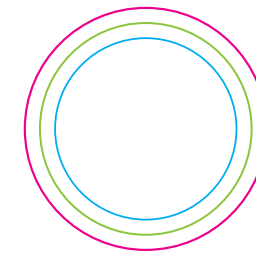

1.1" DAC

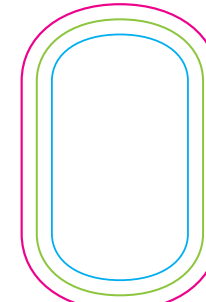

.9" x 1.4" DAS

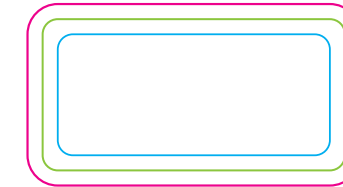

.8" x 1.6" DAR

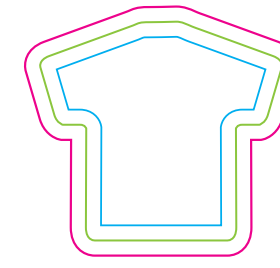

1.1" x 1.3" DAT

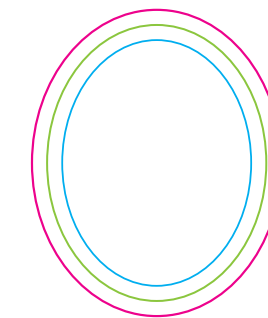

1.1" x 1.4" DAO

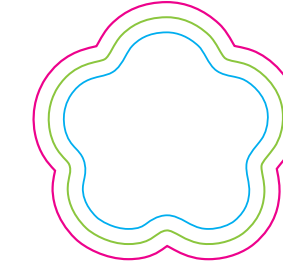

1.2" x 1.2" DAF

B

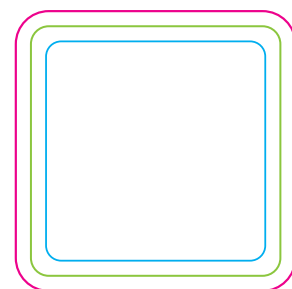

1.3" DBQ

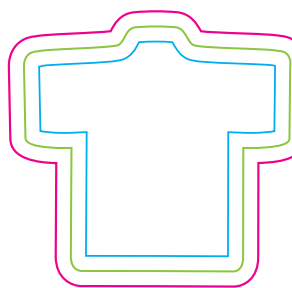

1.3" x 1.4" DBT

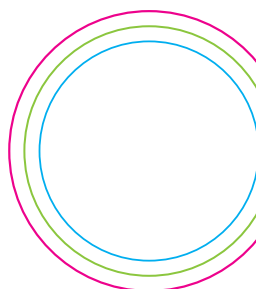

1.3" DBC

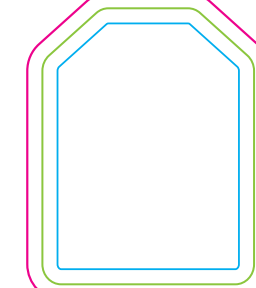

1.1" x 1.5" DBG

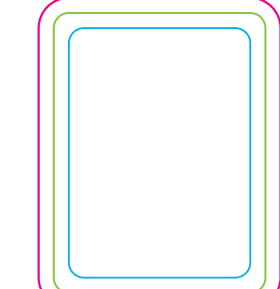

1.1" x 1.5" DBR

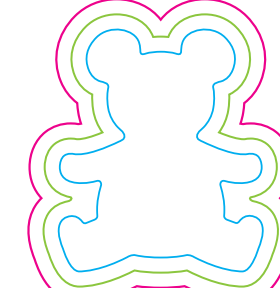

1.2" x 1.4" DBB

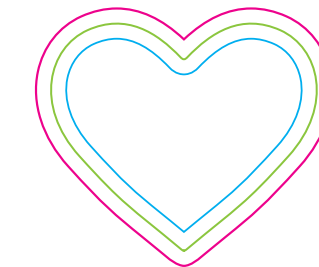

1.2" x 1.4" DBH

BLEED
TRIM
LIVE AREA

D

D series comes on 3.5" x 6" Marketing Card

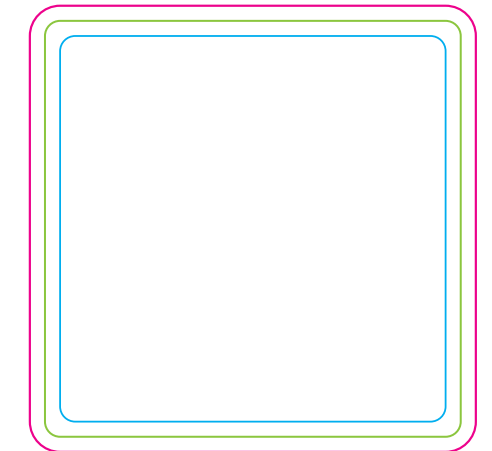

2.2" DDQ

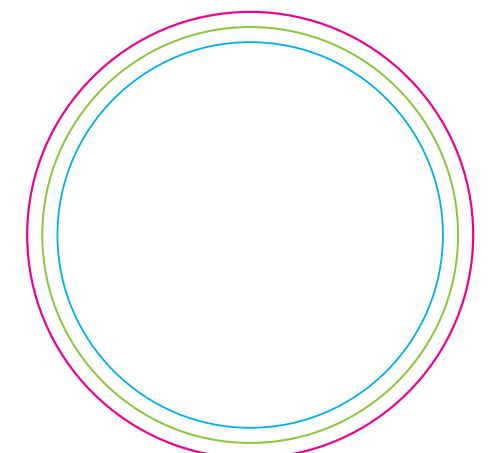

2.2" DDC

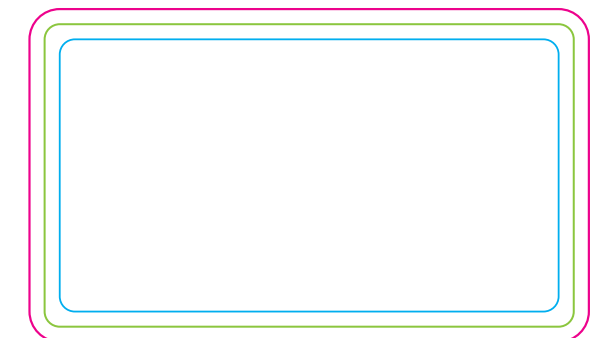

1.6" x 2.8" DDR

C

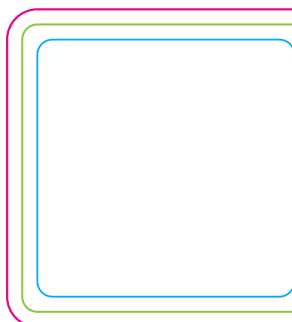

1.5" DCQ

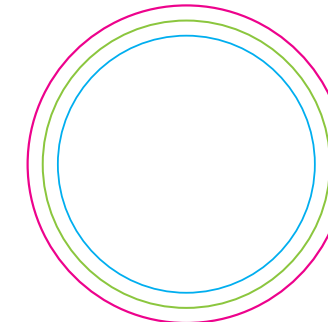

1.5" DCC



1.1" x 1.8" DCR